



Celular Telemetry GSM/GPRS



Technology, Products and Solutions



What is Cellular Telemetry?

Telemetry is a technology that allows remote measurement of physical magnitudes and then forwards the information to the system operator.

Forwarding the information to the operator is made typically by wireless communication, and in the case of Cellular Telemetry, it is done by communication through a Cellular data channel, called GSM/GPRS.

Exemy's Cellular Telemetry solution includes field data

acquisition devices with GPRS communication, device concentration software and different acquisition and visualization tools or final registration of the information.

The main components of the complete solution are:

- 1) Data acquisition (Hardware)
- 2) Communication and Intermediation (Software)
- 3) Access to Information (Final user)

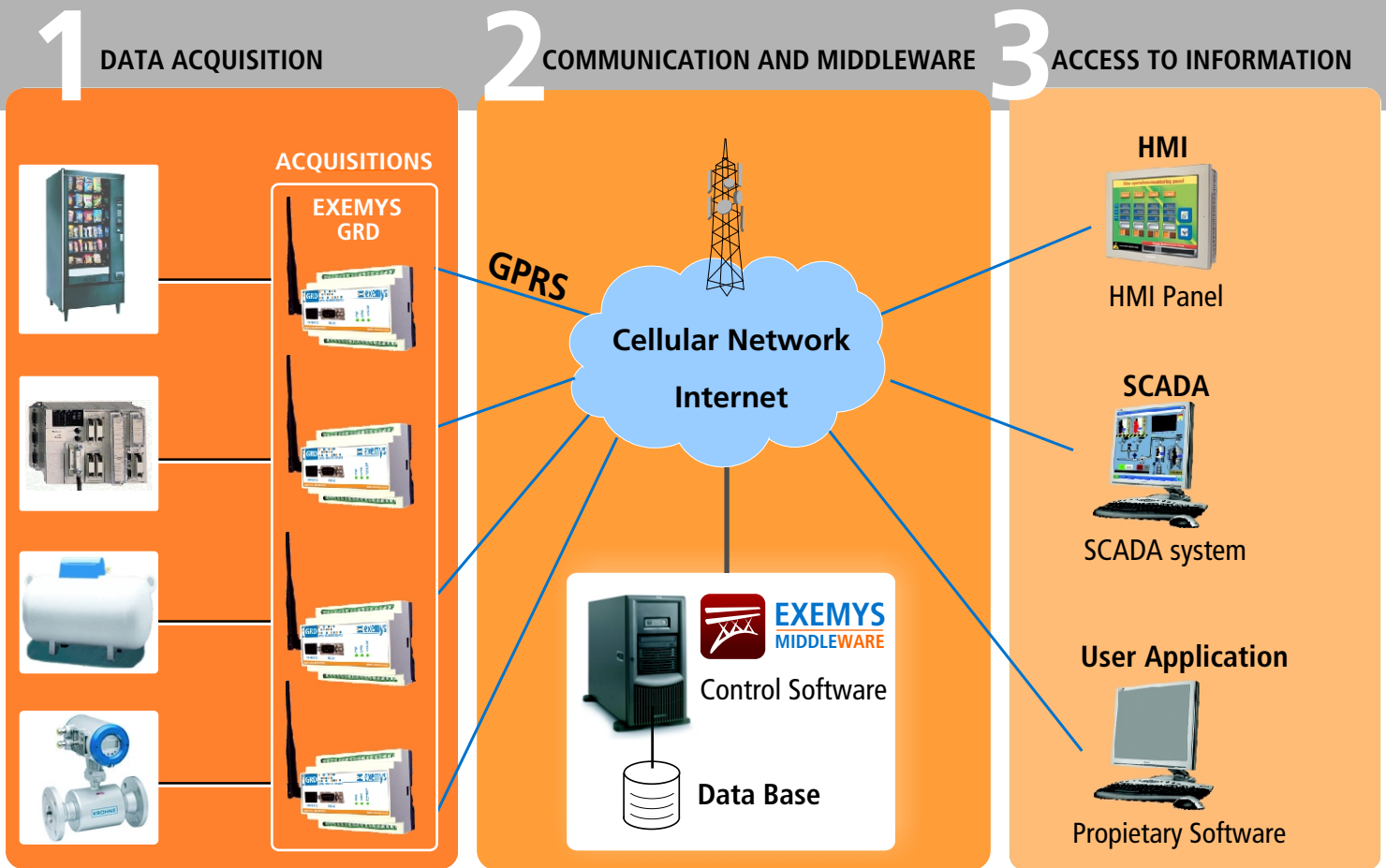

What is a Cellular Telemetry System being used for?

In general the Cellular Telemetry systems are used to measure Remote and Dispersed Assets.

Assets = Money and **Remote** = Distant location

So the greatest strength of a cellular telemetry system is to be able to control money that we have in a distant location.

Focusing the applications from this point of view, the ROI (return on investment) is obtained in a short period of time, which simplifies the materialization of many applications and in multiple market segments.

Terminology

GSM Cellular Communication Technology,

GPRS GSM Data Communication Channel

CSD GSM Data and Voice Communication Channel

Differences between GPRS and CCD

- GPRS Technology: low cost, point-multipoint topology

- CCD Technology: high cost, point-to-point topology

This is why Exemys develops all its Cellular Telemetry products, based on GSM/GPRS technology.



1 DATA ACQUISITION

The data acquisition of different devices, machines or processes to be monitored, is made by the use of electronic devices called GRD acquisition devices. The GRD acquisition devices interact with the outside world, by means of their inputs, outputs and communication ports.

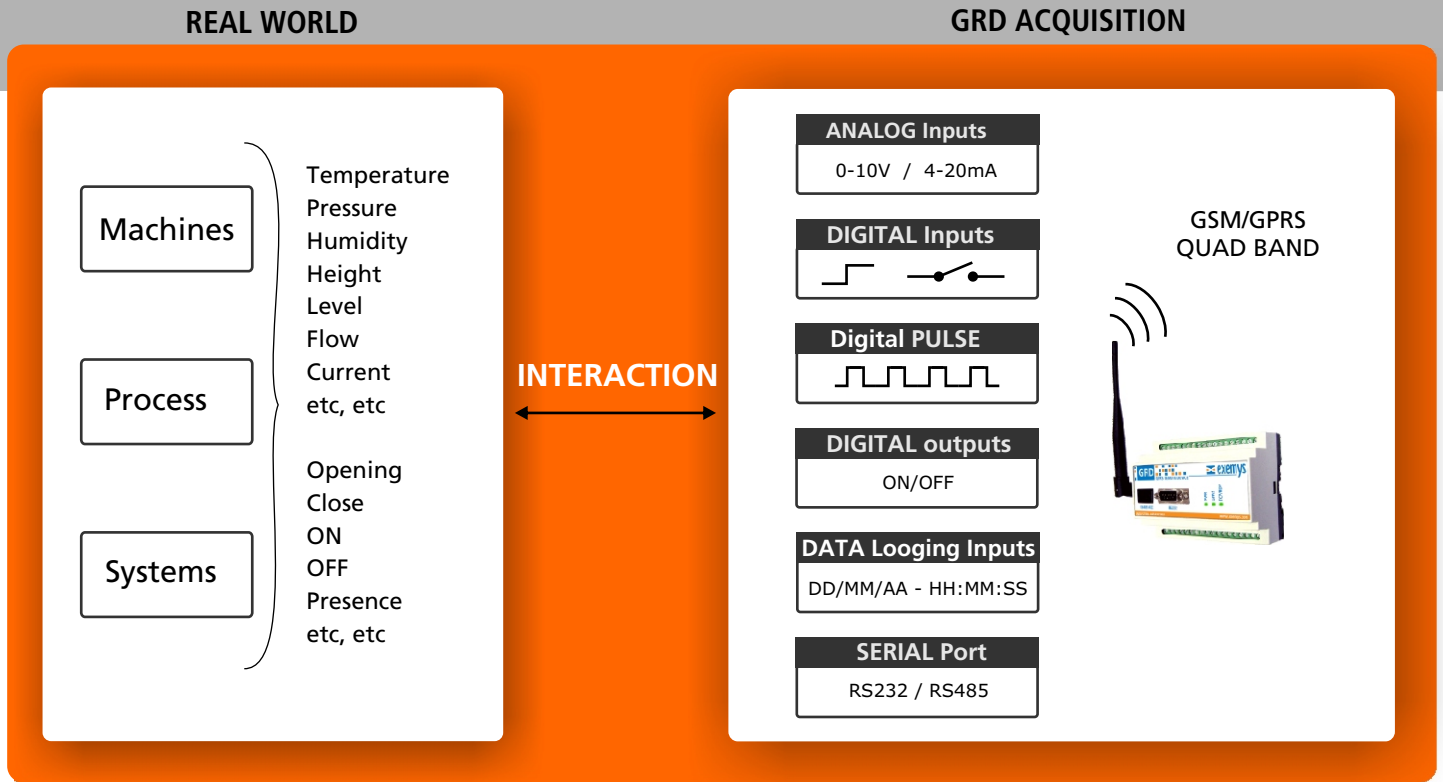

Analog Inputs

Practically every type of variable of the real world can be measured today by means of a sensor and generally the output type of these sensors, through which the measured value is informed, is universal. The most common ones are called Voltage (0-10V) or Current (4-20mA).

Digital Inputs

There are also variables in the real world of the on-off type, activated-deactivated, opened-closed, which means that they have only two states. For this type of signal the GRD acquisition device has digital inputs of the Opto insulated type or the Transistor type.

Digital Outputs

When you want to turn on or off any device or machine in the real world, you need a signal applied to it. For this reason, the GRD acquisition device has Digital Outputs, which can be of the Relay type or Opto insulated type.

Pulse Inputs

Measuring devices, for example electric power consumption meters, communicate the measured values by means of a pulse signal. The faster the signal, the higher the consumption and vice versa. In order to take measurements of these equipments, the GRD acquisition devices have pulse inputs.

Event logging

Generally, in every telemetry system, sample measurements and logging are required and stored for later analysis. The GRD devices have this logging capacity, where events occurring in the real world are registered with date and hour.

Serial Communications Port

When machines and systems to be controlled or measured, have a considerable volume of data, intelligent communication is used and not simply sensor signals. For this purpose, acquisition devices have an RS232 or Rs485 type serial communication channel.



2 COMMUNICATION AND INTERMEDIATION

COMMUNICATION

Cellular telephony networks are those allowing communication between the process and the final user. Currently, GSM/GPRS networks have a high degree of infrastructure development which allows a robust communication and greater signal coverage.

These telephone networks have a "Gateway", or system that links GPRS data with Internet. This way, any communication that develops within the GPRS data channel of the GSM cellular telephony, becomes automatically available in Internet.

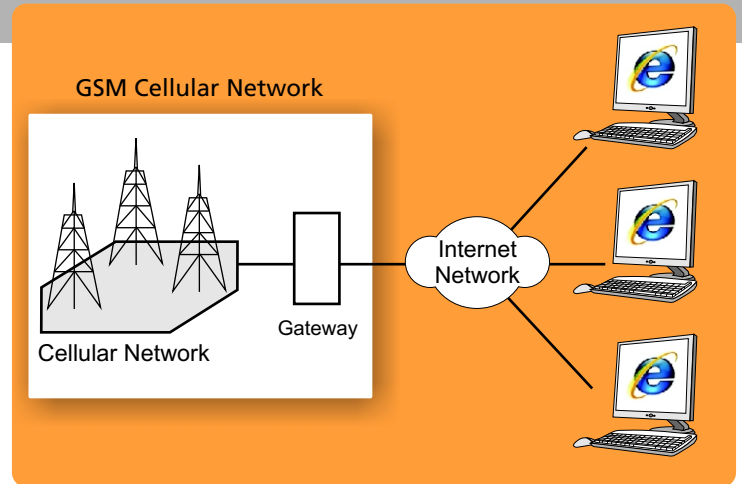

INTERMEDIATION (MIDDLEWARE)

A Cellular Telemetry system can consist of 1, 10, 100 or thousand of remote measuring points. This implies a correct administration of each one of these remote points. This task cannot be carried out by the final user system, since he/she only interested to know the information and not its health.

For this purpose, a software called MIDDLEWARE or intermediation software was designed, which performs the following functions:

To the GRD acquisition devices:

- Carry out the communication between the GRDs and Middleware.
- Control the correct operation of the GRDs.
- Manage additions and deletions and the GRD's own configuration.

To the application of the final user

- Place acquired data in a database (SQL and MySQL)
- Conform a transparent communication channel from the serial ports, to the final application.
- Handle the complexity of the dynamic DNS servers.

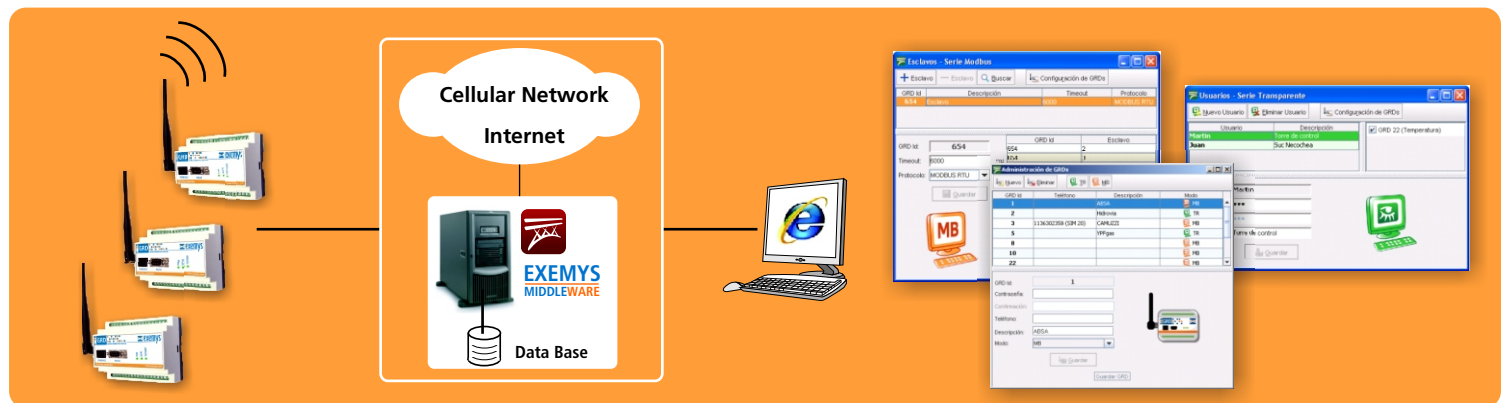

Physical location of Middleware

Middleware is software that can run under a server platform or including a desktop PC platform and can be installed in any computer with Broadband Internet access. That is, it can be hosted on an Internet provider hosting service, as well as the company's own network.



3 ACCESS TO INFORMATION BY THE FINAL USER

What the User Needs

In a Cellular Telemetry system, the Final User needs to be able to access the information from the Remote Asset he wants to monitor in a fast and robust way.

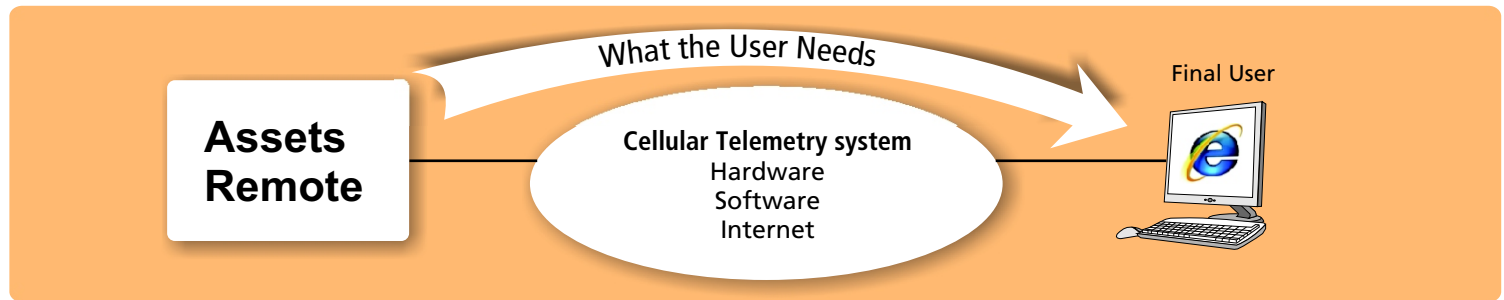

For this, the user has three ways of accessing data:

Web page users

Use of inputs and outputs

The final user develops or subcontracts the development of a Web page, that lets him visualize all the parameters of his application, directly or from any Internet connection.

Middleware registers all information from the inputs and outputs of the GRD acquisition devices, into an SQL or MySQL type of database, which can be read from any Web application designed to that effect, for example by means of JAVA, ASP, PHP or other languages.

Use of RS232/485 Serial Port

The same way in which inputs and outputs are used, an application is developed to take the information from the GRD acquisition devices serial port and presents it on the Web page, or in the reverse direction, it sends data from the Web page to the serial port.



Users of SCADA Software

Use of Inputs and Outputs

To activate the digital outputs of the GRD acquisition devices, the SCADA software records the Modbus records corresponding to the outputs, in the Middleware database, which in turn acts on the outputs of the GRD acquisition devices.

The same way, to read analog or digital inputs, the SCADA software reads from the database, the Modbus records of the inputs, which were previously modified by the GRD acquisition devices.

Use of RS232/485 Serial Port

The users of industrial automation and control systems generally use a supervision and control software generically called SCADA software.

In these cases, the GRD acquisition device is generally connected to an intelligent device, from which information wants to be obtained, and that communicates by means of its serial port, under the Modbus communication protocol.



Users of Proprietary Software

Use of RS232/485 serial port

In the case of application software already developed (canned software); Middleware establishes a transparent communication tunnel between the device to be controlled and the original software of such device.

For this purpose, a redirector of serial ports is installed in the computer where the proprietary software is run. This device redirects the communications that the computer regularly makes with the COM serial ports, towards TCP/IP virtual ports, which are connected to the Middleware.



All the SCADA software systems handle this language or communication protocol. This way, the SCADA software connects to Middleware, by means of the Modbus protocol, which in turn connects to the GRD acquisition devices, in order to be able to access to their serial communication ports.

Therefore, a direct link is established between the SCADA software and the intelligent device, everything through the GPRS communication channel established by the GRD.

Users of custom designed software

Use of Inputs and Outputs

The management of inputs and outputs are made through the database on which the middleware puts the state of inputs and outputs. The custom designed software, can take the data from the database

Use of RS232/485 Serial Port

The serial port of GRD buyer, is available through the virtual serial port redirector, (cellular model) or through a direct connection over TCP / IP to Middleware.





Acquisition GRD

Device for Acquisition and Remote Control, with GSM/GPRS Cellular communication



Features

- Digital Inputs and Outputs, (Opto-isolated, Relay or Transistor).
- Analog inputs for sensors, acquisition devices or Transducers.
- Transparent encapsulation of serial Communication protocols.
- TCP/IP communication over a GPRS data network.
- Optimization of use of the cellular network.

Models

FAMILY	SERIAL PORT	DIGITAL INPUTS / OUTPUTS	ANALOG INPUTS	TYPE OF ANALOG INPUTS	COUNT INPUTS
GRD1000	RS232/485	---	---	---	---
GRD2001	RS232/485	16/14	---	---	---
GRD3002	RS232/485	16/6	6	6 x 0-10Vdc	---
GRD3003	RS232/485	16/6	6	6 x 4-20mA	---
GRD4002	RS232/485	16/6	4	4 x 0-10Vdc	2
GRD4003	RS232/485	16/6	4	4 x 4-20mA	2

Specials features

- Pulse count input for meters.
- Time stamp datalogging.

Middleware

Integration software for Cellular Telemetry applications

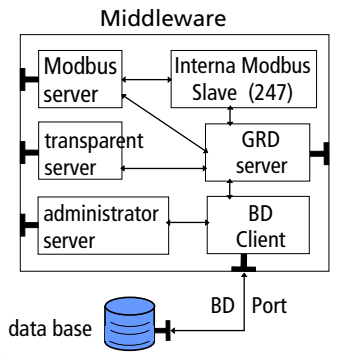
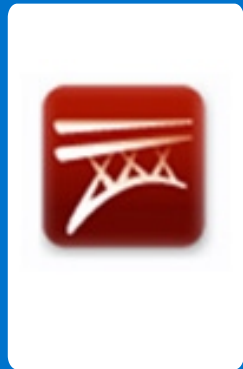

Modbus Server: This is a server accepting Modbus connections through a configurable port. It can receive Modbus TCP, Modbus RTU over TCP or Modbus ASCII over TCP connections.

Transparent Server: This is a server accepting connections directly from the serial port Redirector in a configurable port. The port redirector has an authentication mechanism through www.exemys.com Rev 2.1.0 - Junio 2009 10MW User's Manual Exemys a configurable user and password, once authenticated a virtual serial port in the redirector PC is opened which is directly linked with a serial port of a determined GRD.

Administrator's Server: By means of this server it is possible to connect with an administrator capable

of modifying all MW configurations, for example, communication ports, GRD operational modes, users, passwords, etc.

GRDs' Server: This is server that accepts connection of GRDs, which when connecting with the MW are authenticated through an identification number and a password. Through this channel all data from or to GRDs enter and exit.

DB Client: A client to an SQL Database. When enabled all data from equipments, reports or historical are dumped.

Internal Modbus slave: This is a Modbus slave which is accessed through the Modbus connections server with the ID 247. It has the updated values of all inputs and outputs of the GRD.

Middleware licenses are per connection point

Redirector de Puertos Virtuales

Redirector de Puertos Serie a TCP/IP, para aplicaciones de Telemetría Celular

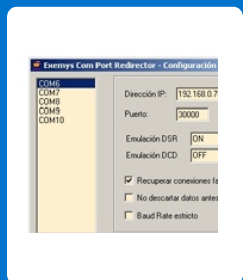

Before

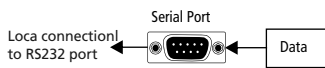

After

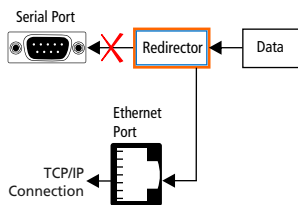

MW Redirector Software creates virtual Com Ports for applications to use remote cellular devices (GRD), with no change to application software

Software licenses are free

Accessories

Accessories for mobile telemetry facilities



- Cellular Antenas
- Solar Panels
- Industrial Power supplies
- Batteries



Oil and Gas: Gas Pumps

Country: Bolivia

GAS PUMPS

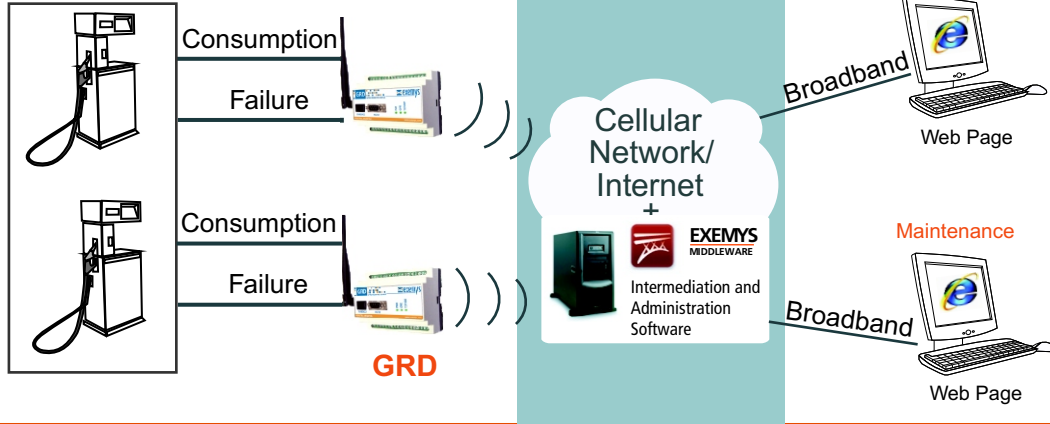

Benefits:

- Elimination of regular visits to the pumps
- Reduced spending Logistics and Transportation
- Periodical report of alarms, to the technical support
- Permanent information of consumption for Management control

Industrial Automation: Measurement of environmental parameters

Country: Escocia (UK)

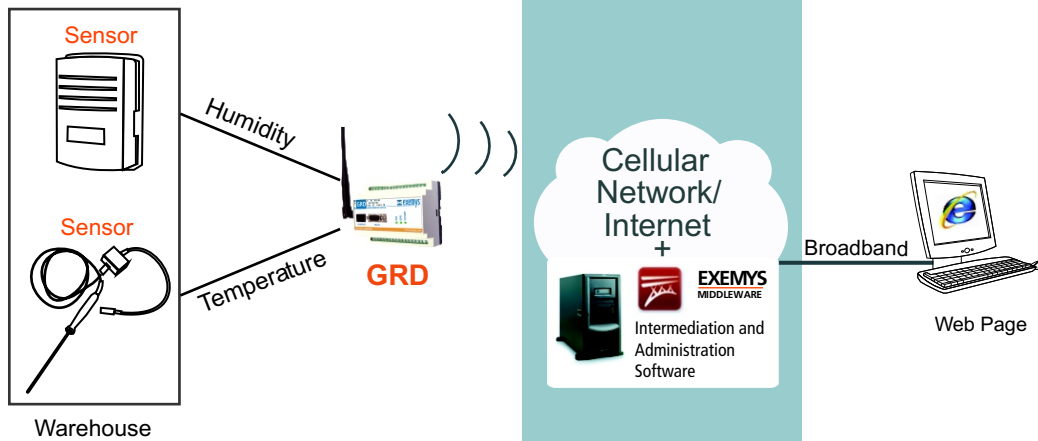

Benefits:

- Permanent information for the care of the valuable stock of the deposit
- Report ongoing environmental anomalies
- Data on-line for maintenance sector

Exemys Cellular Telemetry active currently in:

- ARGENTINA
- BOLIVIA
- BRASIL
- BULGARIA
- CANADA
- CHILE
- COLOMBIA
- ESPAÑA
- GUATEMALA
- HONDURAS
- INDIA
- PARAGUAY
- REINO UNIDO
- URUGUAY
- USA





Water and Sanitation: Consumption of drinkable water Country: Argentina

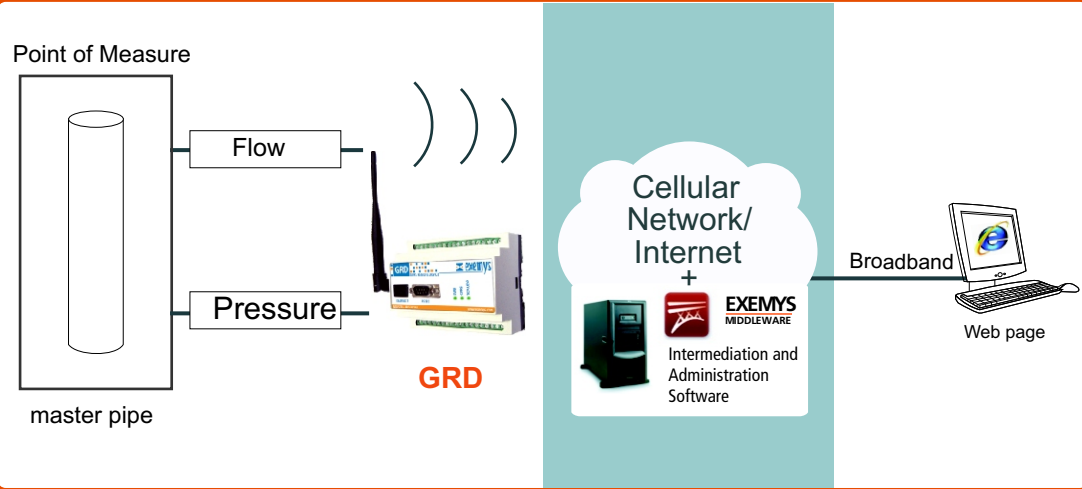

Benefits:

- Constant Report abnormalities in water distribution service
- Permanent information to the management level
- Compliance with regulatory requirements

River Transport: Weather and River Information Country: Argentina

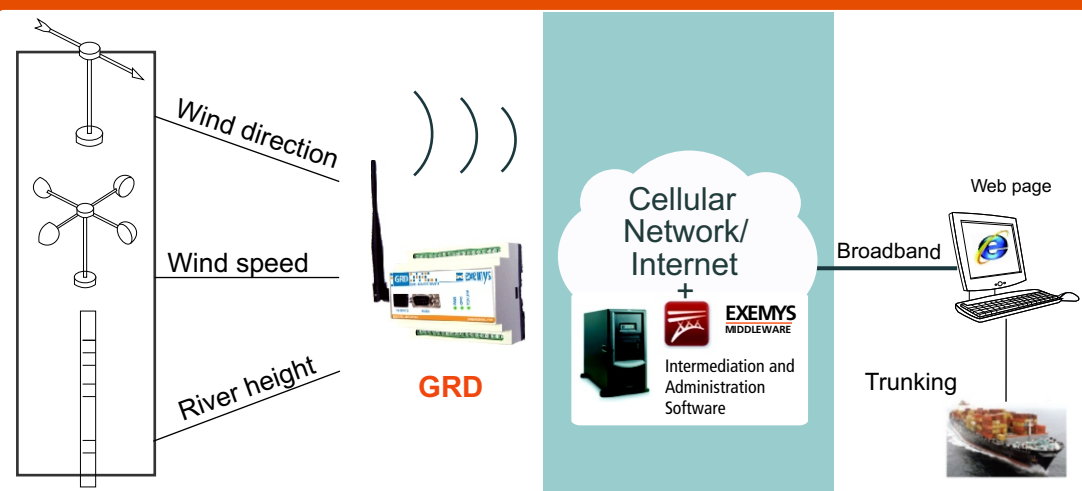

Benefits:

- Anticipation of adverse events for navigation
- Permanent information for ships and cargo vessels
- Reduced costs navigation

SISTEMA DE GESTIÓN ISO 9001:2000



PRODUCTOS CON CERTIFICACIÓN DE SEGURIDAD ELÉCTRICA UL 60950



LEY DE SOFTWARE EMPRESA CERTIFICADA



Av. Juan B. Justo 4054 - C1416DJU - Ciudad Autónoma de Buenos Aires - Argentina

US Tel: 1 (408) 540-6009 USFax: 1 (208) 567-9279 E-mail: exemys@exemys.com

www.exemys.com